

Report on cellulose pilot



DATE: 03/03/2021

NAME: Report on the production of biochar (activated carbon), bio-oil and pyroligneous acid from cellulose

SUBJECT: WP2.3.1: Final report on pilot results

Contents

1.....	Introduction	4
2.....	Materials and methods	7
2.1.....	Design of pilot plant	7
2.2.....	Cellulose sieves	9
2.3.....	Drying and pelleting	13
2.4.....	Pyrolysis process	15
2.5.....	Activation biochar	17
3. Results and discussion.....		20
3.1. Cellulose screenings.....		20
3.3. Pyrolysis.....		21
3.4. Activation.....		26
3.5. Removal efficiency for pharmaceuticals		27
3.6. Design full scale plant.....		31
4. Conclusions		33
5. References		35

List of figures

Figure 1: Recovery of carbon based elements for sewage in WoW!.....	4
Figure 2: Pyrolysis products made from cellulose derived from wastewater.	6
Figure 3: The different steps of the whole process from cellulose screening till pyrolysis.....	7
Figure 4: Dimensioning (mass balances).....	8
Figure 5: Building and layout of the pilot plant	9
Figure 6: Finesieves and dimensions	10
Figure 7: Finesieves in Ede.....	11
Figure 8: particle size distribution influent WWTP Ede.....	12
Figure 9: Sample point Influent.....	13
Figure 10: Sample point Filtrate and sieved material	13

Figure 11: Drying section including pellet press and intermediate products	14
Figure 12: Pyrolysis section including separator and products	15
Figure 13: Dry matter content and Ashcontent in the sieved material	20
Figure 14: Solids and Ash of the sieved material vs pressed material	21
Figure 15: The temperature inside the reactor and in the preburner	22
Figure 16: Biochar produced	23
Figure 15: Density vs temperature of Bio-oil (dry and wet layers) and pyroligneous acid	25
Figure 18: average removal efficiency for all 11 guiding substances	29
Figure 19: average removal efficiency for the 7 guiding substances with the highest removal efficiencies	29
Figure 20: DOC concentration per biochar test	30

List of tables

Table 1: particle size distribution in Influent WWTP Ede	11
Table 2: Initial design parameters and operating conditions	12
Table 3: Set parameters for the activation of biochar at the University of Hasselt.....	17
Table 4: settings used for physical and chemical activation of biochar at the University of Évora	18
Table 5: Active Biochar tested at Leaf Wageningen	19
Table 6: average quality sieved material.....	21
Table 7: the production batches of biochar that have been done	22
Table 8: Properties produced biochar compared to biochar from Aarle-Rixtel	23
Table 9: Composition of bio-oil compared with other bio-oils and burner fuels.....	24
Table 10: Analysis on the pyroligneous acid produced.....	25
Table 11: results ash content after before and after activation	27
Table 12: the concentrations of the guiding substances before and after the adsorption tests with the different activated biochar	28
Table 13: removal efficiency per guiding substance per biochar tested	31

1. Introduction

Sewage contains valuable substances that can be used as raw materials for biobased products. However, to date this potential has hardly been exploited to its full potential in North-West Europe. This results in loss of valuable materials, CO₂-emissions and less efficient use of natural resources. The Interreg North-West Europe project WOW! - Wider business Opportunities for raw materials from Waste water (sewage) - aims to develop three value chains for the recovery of carbon based elements from sewage (see figure 1.1):

1. **The production of biodiesel.** The sewage inflow is used to cultivate *Microthrix p.* which can accumulate lipids. The lipids are extracted, processed and transformed to biodiesel.
2. **The production of bio-oil, biochar and acetic acid.** The screening material which mainly consists of cellulose material (toilet paper) is dewatered and dried. In a thermal degradation process (pyrolysis) the dried cellulose material is converted into biochar, bio-oil and acetic acid.
3. **The production of PHA (bioplastic).** For this the primary sludge is used. In a biological process, PHA is enriched and extracted. Then the PHA is compounded and processed to an end product.

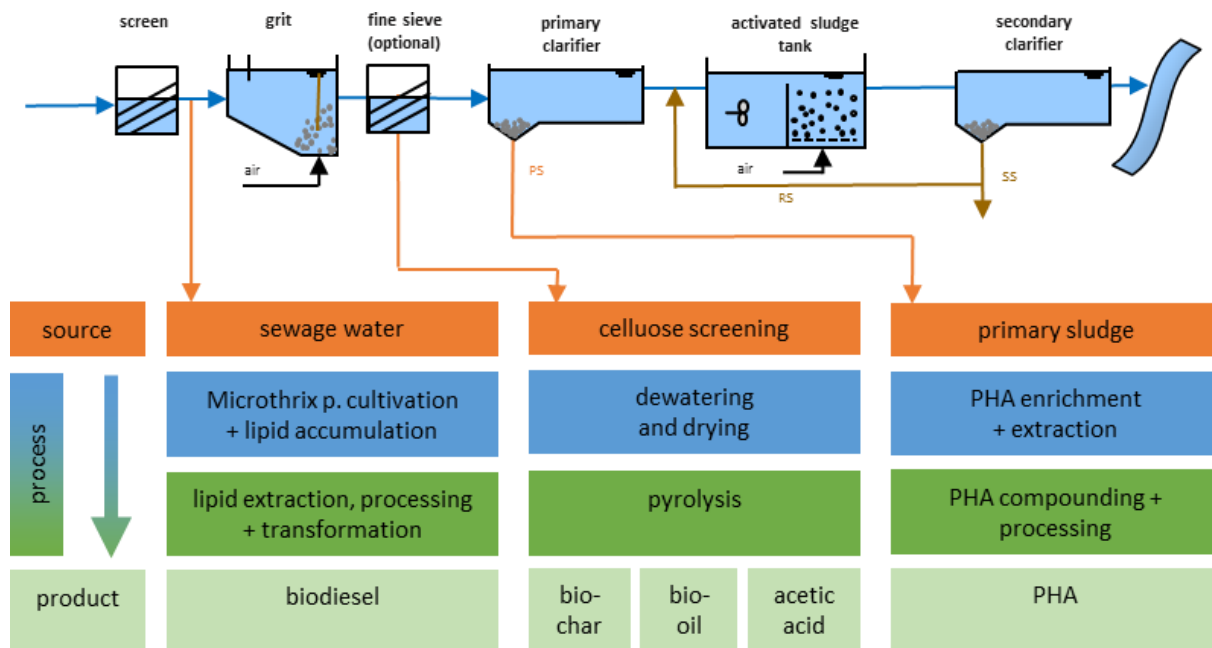

Figure 1: Recovery of carbon based elements for sewage in WoW!

One of the main activities of the project was to demonstrate the technical feasibility of these three value chains in three separate pilots with a focus on optimisation of the different recovery and upcycling techniques and tailoring the products to market needs.

This report focusses on the possibilities to use cellulose screenings as a starting material to produce valuable products such as biochar, bio-oil and acetic acid for subsequent use at the wastewater treatment plant. The goal of the project was to investigate whether these materials would be good alternatives for crude oil and especially coal. If so, this would provide interesting opportunities for our goals as a Water Authority to stimulate the circular economy and reduce the environmental impact of the wastewater treatment processes. Biochar is a carbon material that can be produced by carbonization of various biobased materials. Biochar can absorb organic and inorganic contaminants in soil and wastewater and can therefore be used in the wastewater treatment process to improve the water quality of the effluent. Activated biochar is added to the activated sludge to remove those pharmaceuticals from the wastewater that are normally not degraded in the activated sludge and therefore end up in the surface waters after discharge of the effluent. The activated biochar that is currently in use in wastewater treatment plants, is derived from coal which has a relatively high environmental footprint. In several studies, different biomass materials have been tested for their suitability to be a source of biochar including different species of grasses, coconut shells, manure and different types of soft and hard wood. The percentages of (hemi)cellulose and lignin in the feedstock source vary and this in combination with the pyrolysis temperature (ranges of 200- 800 °C have been tested) ultimately determine the physicochemical properties of the biochar including size of the surface area, the number of functional groups, the hydrophobicity and stability and thereby their ability to bind (in)organic contaminants and heavy metals. Pyrolysis at high temperatures results in high carbon and ash content, larger surface area and pore size but lower yields (Hassan et al., 2020).

In our pilot cellulose screenings, collected from the wastewater, were dewatered, dried and pelletized. After another drying step, the pellets were fed to the flash pyrolysis reactor and converted into the following products:

Pyrolysis Products

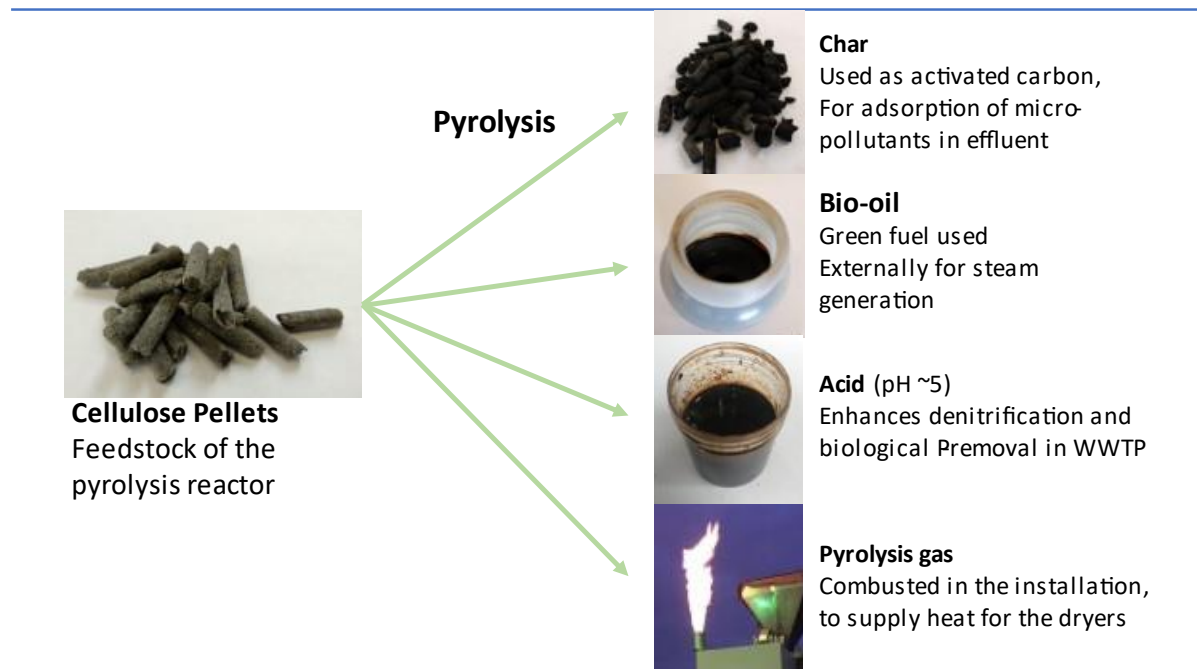

Figure 2: Pyrolysis products made from cellulose derived from wastewater.

Samples of the biochar were subsequently activated using three physical and two chemical methods and subsequently tested for their binding capacity of 11 pharmaceuticals in the wastewater of Ede. This set of reference pharmaceuticals has been selected by the national government and is the set that mostly used to test the removal efficiencies of different biochars.

The pilot was conducted to answer the following research questions:

- What is the quality of the cellulose screenings derived from the wastewater of the WWTP in Ede?
- What is yield and quality of the different pyrolysis products?
- Can the biochar be activated and what is the removal efficiency of the activated biochar for a defined set of pharmaceuticals?
- Is it feasible to design and implement such a technically complex configuration on a conventional WWTP?

2. Materials and methods

2.1. Design of pilot plant

In this research programme the step from lab scale to pilot scale is made. The pilot consists of many stages as depicted in figure 3: 1. Sieving of cellulose out of WWTP influent (zeven); 2. Dewatering of the sievings (ontwateren); 3. Pre-drying (drogen); 4. Pelletization (persen pellets); 5. Post-drying (nadrogen); 6. Pyrolysis (pyroflash reactor) and 7. Separation of pyrolysis products (pyroflash scheiding)

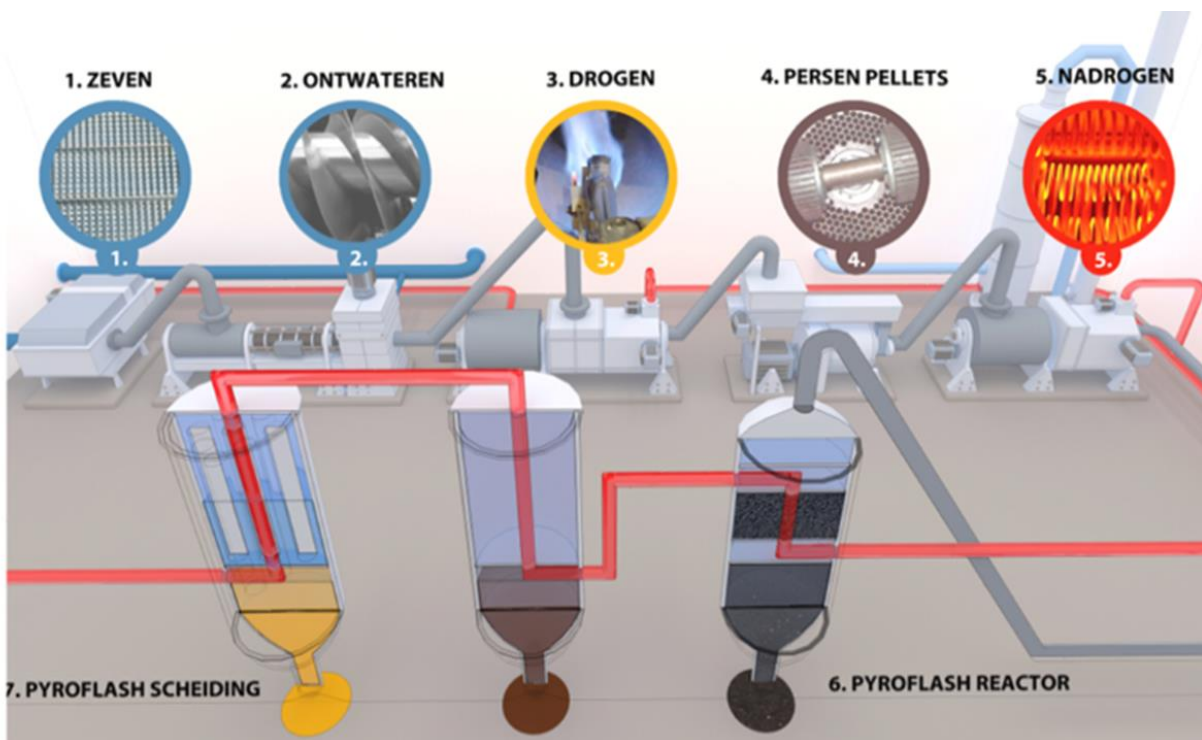

Figure 3: The different steps of the whole process from cellulose screening till pyrolysis

Because all steps should be representative for a full-scale situation, the pilot could be considered a *demonstration* plant treating a dry weather flow of over 400 m³/h which is comparable to an WWTP treating the wastewater of approximately 50.000 PE.

The original intention was to develop a continuous process to get most benefits: for instance, the syngas produced in the pyrolysis reactor could be used in the drying process thus optimizing the energy configuration. But to allow for differences in capacities of all stages intermediate buffers were incorporated.

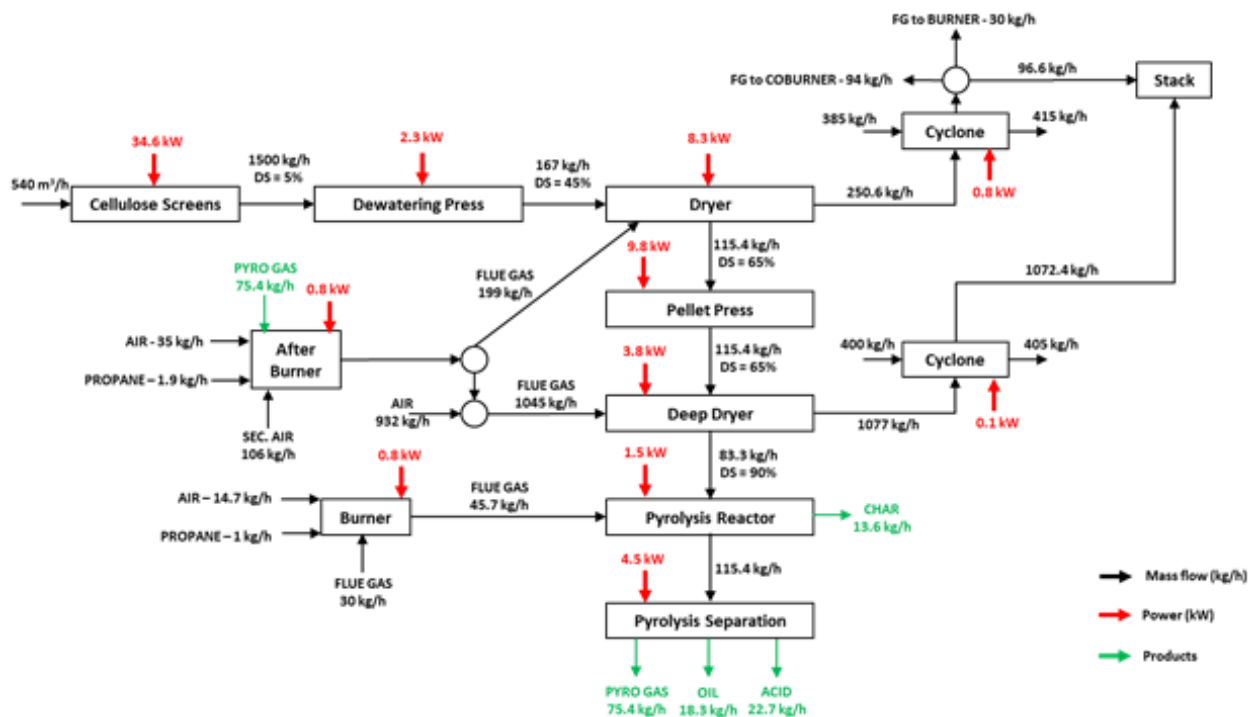

Figure 4: Dimensioning (mass balances)

Beside the performance of all stages, separate and combined, the quality and quantity of the products (biochar, bio-oil and acid) are important as well as the potential activation of the biochar to activated carbon for removal of pharmaceuticals.

A new building (30 m length, 10 m width and 5,6 m height) was erected consisting of a wet section (sieves and dewatering of sievings) and a dry section (drying, pelletization and pyrolysis).

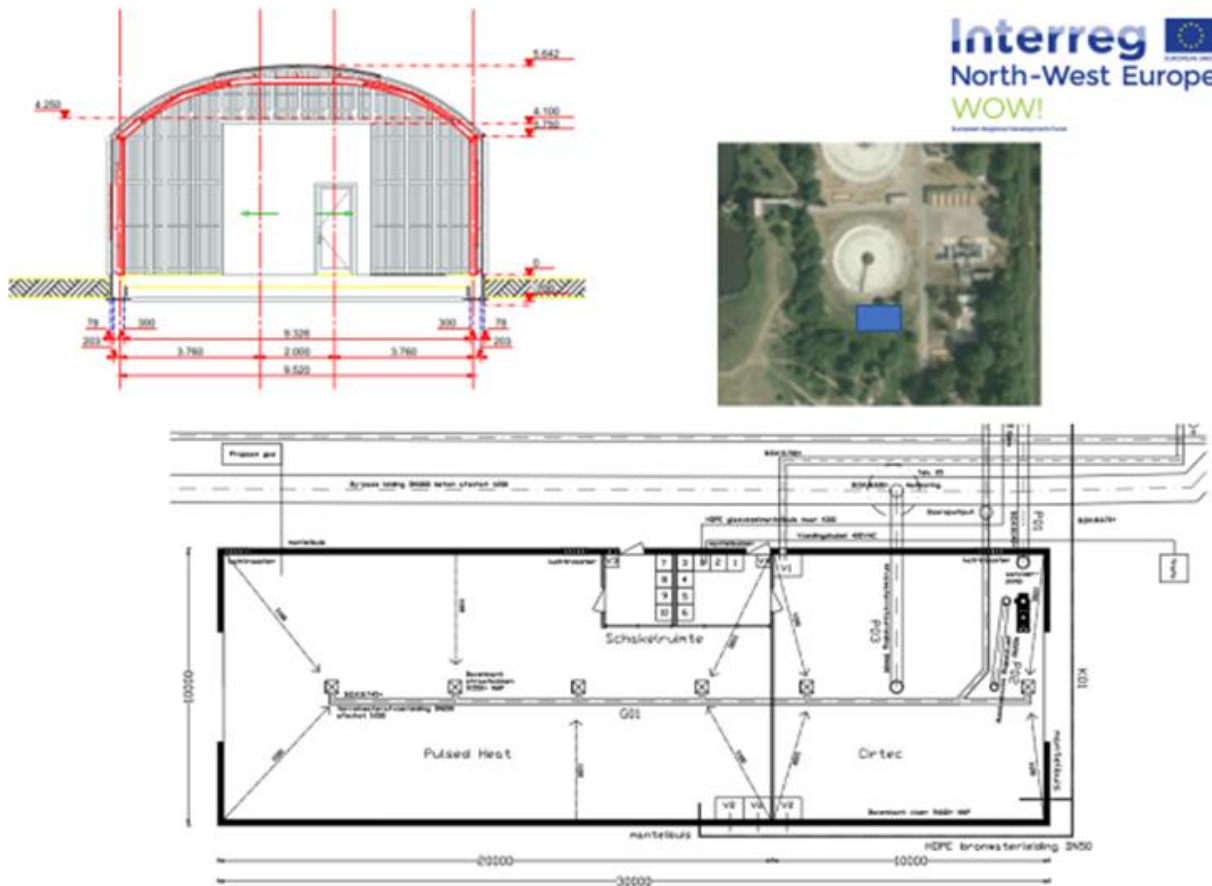

Figure 5: Building and layout of the pilot plant

In the next paragraphs the stages are described in more detail.

2.2. Cellulose sieves

For capturing cellulosic screenings, rotating belt fine sieves (RBF) were installed. These filter systems have been installed around the world in a variety of applications within sewage treatment plants, as well as in industrial solids separation applications.

An RBF combines two critical processes into one compact unit - solids separation and solids thickening. The rotating filter mesh removes TSS and produces thickened screenings. It is a filter design that can replace conventional primary sedimentation.

The RBF is designed for high efficiency solids removal from sewage streams. It is particularly effective for removing suspended solids (TSS) from liquid streams, improving water quality and possible options for further processing or discharge. The machine has been designed to handle (waste)water streams which, next to solids, may contain high concentrations of fats, oils, or grease (FOG).

Depending on the application, the sieve can be equipped with a filtermesh with one size mesh opening sizes that can range from 90 to 2000 microns. The feed water is continuously fed into the unit in which the filtrate escapes through the mesh. The suspended solids that are separated by the mesh form a pre-coat which increases the efficiency, by catching smaller particles.

The movement of the mesh is continuously, where the speed is controlled, based upon the liquid level in the machine.

The filtrate (free water) is first collected behind the filter mesh in the frame from where it is being discharged. The solids will be removed from the filter mesh by means of a specific designed cleaning system, using low pressure air.

Cellulose Screens and dewatering

Schematic of the sieve

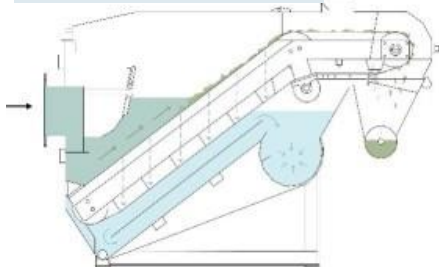

- Hydraulic capacity: 300 m³/h per sieve
- Mesh size: 90-1000 micron (350 μ mesh used)
- Pre-coat → removal smaller particles
- Mesh cleaning (low pressured air)
- Dewatering by a press (45...50% DS)



Figure 6: Finesieves and dimensions



Figure 7: Finesieves in Ede

For the application at the wastewater treatment plant (WWTP) at Ede, a filtermesh with a pore size opening of 350 microns was used based on the particle size distribution (average value out of 8 samples), in Ede which was determined prior to installation (see table below). Of the particles, 27% was larger than 350 μm . As a rule of thumb, it can be stated that over 20% of the TSS present in the water should be larger than the pore size of the filter mesh.

Table 1: particle size distribution in Influent WWTP Ede

Particle size (micron)	Concentration (mg/l)
<55	14,33
55-120	27,16
120-158	36,86
158-210	70,35
210-350	87,78
350-500	58,50
>500	29,31
Total	324,29

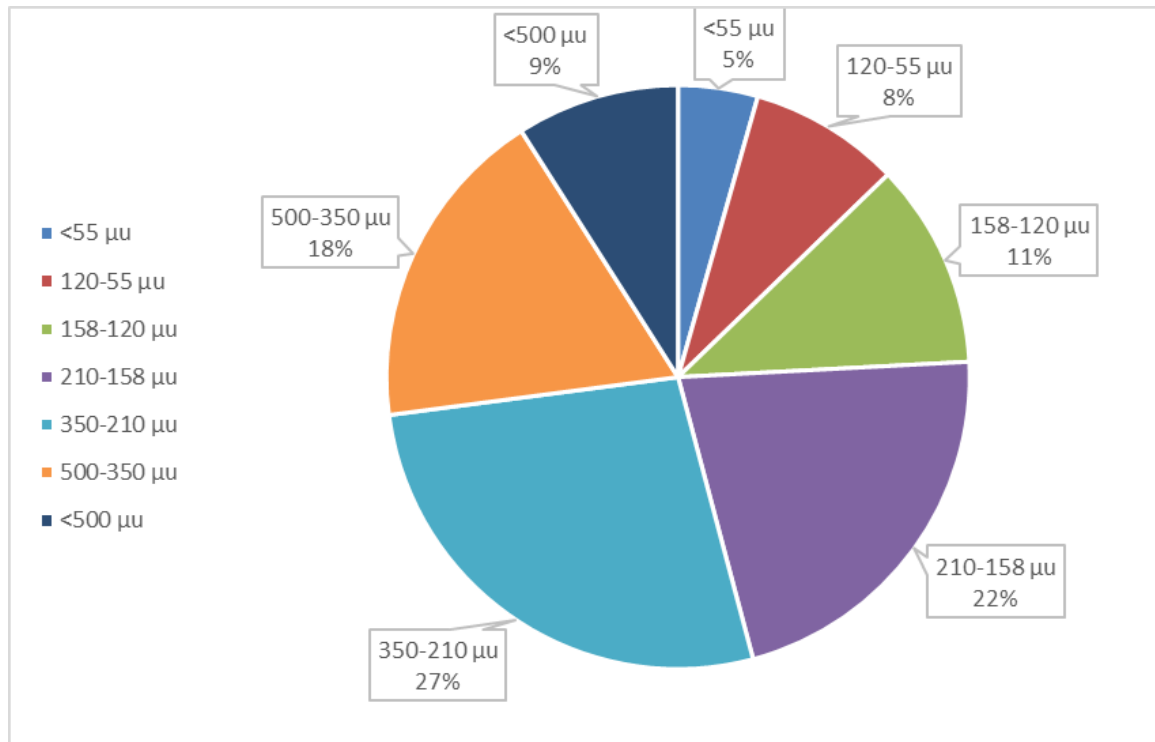

Figure 8: particle size distribution influent WWTP Ede

Table 2: Initial design parameters and operating conditions

Feed to Finesieves	Min	avg	max	unit
Capacity	420	540	640	m ³ /h
COD	45	281		kg/h
BOD	13	95		kg/h
TKN	5	24		kg/h
P _{tot}	1	4		kg/h
TSS	17	117		kg/h
COD	106	521	1959	mg/l
BOD	31	175	648	mg/l
TKN	12	44	96	mg/l
P _{tot}	2	7	19	mg/l
TSS	40	217	1135	mg/l

The characteristics of the influent and the filtrate derived from the finesieves were compared by taking samples by an automatic sampling station and an outlet of the sieves respectively. Also, from the sieved material, samples of fixed volumes were taken every hour during running time and mixed. From this mixture

a representative sample was sent to Aqualysis for analysis for COD levels, suspended solids and ash content.

For the sampling, it was assumed that the inflow and outflow of the wastewater to the cellulose screens was constant. The sampling points for the influent and filtrate are shown in figure 9 and 10. Influent was sampled using an automatic sampler which took a sample every 5 minutes out of an influent overflow IBC.



Figure 9: Sample point Influent

250 ml of filtrate sample was taken manually every hour and was added to a collection tank. The sample send for analysis was a combined sample out of this tank.



Figure 10: Sample point Filtrate and sieved material

2.3. Drying and pelleting

Figure 7 shows the drying and pelleting process.

Drying section

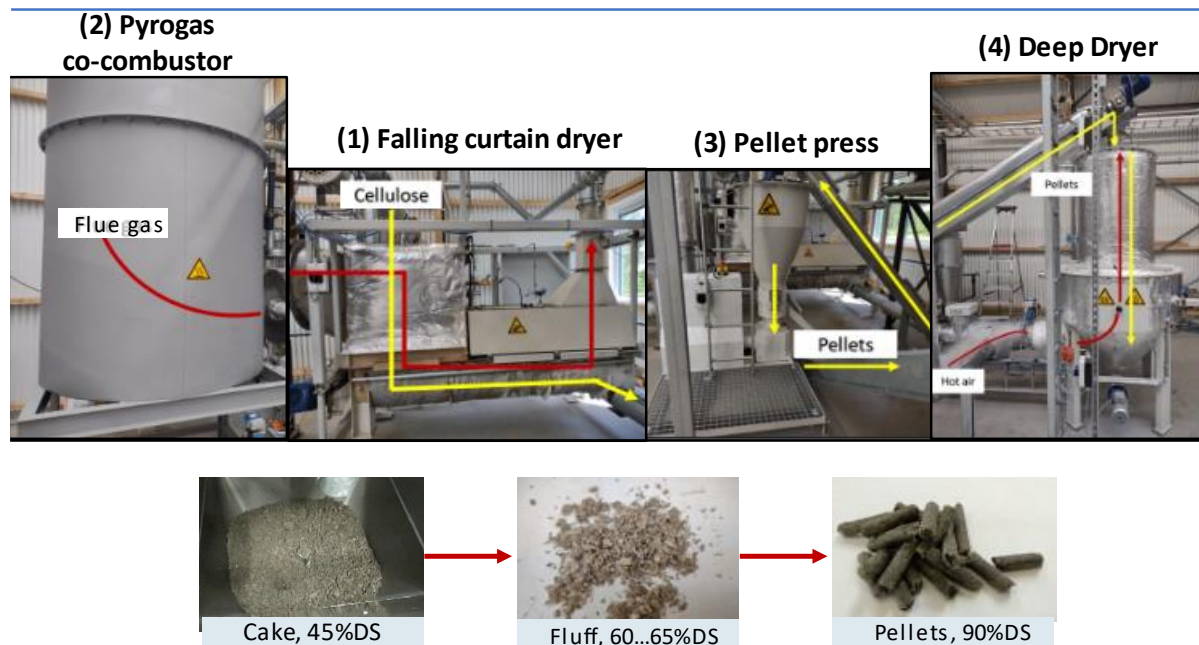

Figure 11: Drying section including pellet press and intermediate products

The drying process takes place in a so-called Curtain Dryer. The pressed cake is being dried using a mixture of air and flue gas. These gases were produced in the pyrolysis co-combustor. The pressed cake is then taken to the pellet press by paddles. The dried pressed cake (fluff) leaves the dryer at a temperature of 60 °C with a dry solids content of 65-70 %. The wet fume gasses have a temperature of 120 °C and are taken to a hydrocyclone. By using the flue gases as medium, a low oxygen environment (6 to 10 vol% O₂) is being created.

The pressed cake is then converted into pellets with a diameter of 6 mm. The pellets leave the pellet press at 70 °C. These pellets are then transported to a secondary drying unit which is used to dry the pellets to a dry matter content of 90%. The secondary drying unit is fed with a mixture of flue gas and air at 120 °C. The hot gases flow countercurrent through the column and leave the dryer at 40-45 °C. The process is controlled by an infrared temperature sensor and the regulation of the ventilator.

The pellets are then transported to a buffer tank before they enter the pyrolysis Flash reactor. The expected advantage of a flash reactor compared to a more conventional pyrolysis reactor was that the

temperature can be kept lower thus reducing the gasification of the carbon which would result in a higher yield for biochar (and bio-oil).

To avoid brooding and explosions, the secondary dryer is considered to be an Atex explosion zone 22. It will be operated at under-pressure (-15 tot -5 mbar) thus ensuring that no dust escapes. It also has a spraying unit if necessary.

2.4. Pyrolysis process

Figure 12 shows the Pyrolysis installation as well as the sample points for the Biochar, Bio-oil and the pyroligneous acid.

Pyrolysis section

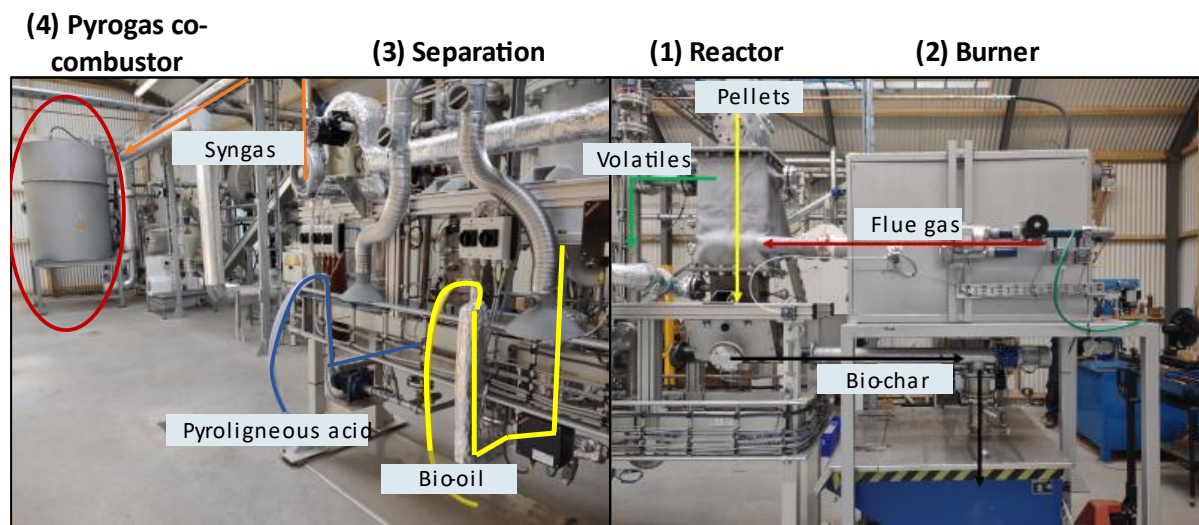

Figure 12: Pyrolysis section including separator and products

The installation can be split up into 4 different sections as shown in figure 12.

The dried cellulose pellets are transported to a buffer tank before they enter the pyrolysis Flash reactor. The reactor is fed by a screw which brings the pellets to the top of the Flash reactor. The pellets slowly sink into the reactor where they are heated up. First the leftover water fraction evaporates after which the pellets start rising in temperature. At 250 °C, the pellets start to degas after which the pellets are heated to

(maximum) 900 °C combined with the flue gas in the combustion zone. The flue gas comes from the propane preburner. The flue gas is diluted with low oxygen gases from the hydrocyclone. The pellets are moved to the product tank where they arrive at 80 °C.

Separation

The pyrolysis gas leaves the reactor at 200 °C after which they are quenched with water. The suspended substances are added to the acid fraction circuit. The rest of the gasses are transported to a secondary separator which mechanically removes pyrolysis oil droplets from the gas at a temperature of 100 °C. The Oil (70 °C) is transported to an IBC by means of a gear pump. The bio-oil has a high viscosity and the circuit therefore is traced to keep the oil on the right temperature and prevent it from settling in the piping.

The gas is then transferred to a water-cooled shell & tube condenser which removes the acid fraction from the gas phase. The acid condensate is circulated by a pump and periodically drained. The syngas that is left is transported to the co-combustor.

Co-combustor

In the top of the co-combustor a propane burner is placed. By the vortex the pyrolysis gas and the flue gas recirculation are added. The temperature rises up to 850 °C. Then the post chambers (retention time 2 sec minimum) follow the flue gas curtain dryer and or the secondary dryer. The temperature can be controlled by the propane burner.

Offgas

The flue gas from the curtain dryer is directed via the hydrocyclone to the chimney. In the cyclone water is nebulized (300 micron drops) co-current to catch solids and cool the off gas from 120 °C tot 70 °C. After the cyclone, part of the gas goes to the co-combustor and another part to the preburner. The offgass of the secondary dryer goes to another hydrocyclone to remove particles and cool down from 50 to 30 °C and after that also to the chimney.

Capacity of the pilot plant

This system can in theory treat 1500 kg/h of 5% sieved material. The expected biochar production is 13,6 kg/h. The Pyrolysis oil and acid production were calculated at 18,4 kg/h and 22,6 kg/h respectively. During this, a total of 75,8 kg/h of Pyrolysis gas will be produced.

This is the theoretical capacity if the unit is in continuous operation. However, the pyrolysis plant was considered too complex to run unmanned and therefore we only obtained a permit from the competent authority to operate the pyrolysis reactor during daytime. As a result, we had to work with batches.

Pyrolysis products

The Biochar samples were collected in a bin. The Bio-oil was collected in a 20 liter collection tank. The pyroligneous acid was collected in an IBC.

2.5. Activation biochar

Samples of the biochar were activated at the University of Hasselt (Diepenbeek, Belgium) as well as at the University of Évora (Portugal).

University of Hasselt

The activation at the university of Hasselt was performed in a tubereactor with the following parameters:

Table 3: Set parameters for the activation of biochar at the University of Hasselt

Parameter	Value
Amount Biochar	15 mg
Water	333 ul
Temperature	850° C
Heating Rate	20 oC/min
Duration	30 min

Thermogravimetric analysis was performed on the bio-oil and the biochar and Porosity analysis was performed on the activated Biochar.

Univerisity of Évora

In Portugal, the biochar was thermally treated and subjected to several carbonisation, physical and chemical activation processes in a horizontal furnace. In the carbonisation, which was carried out in an inert atmosphere (N₂), the biochar was heated at a heating rate of 10 °C/min up to 850 °C, and remained at this maximum temperature for 30 min. The cooling to room temperature also took place in an inert atmosphere (N₂).

In the physical activation processes, different activating agents were used, namely carbon dioxide, air, and water vapour (steam). In these processes the biochar was subjected to heating under similar conditions as the carbonised (i.e. fixed rate of 10 °C/min, maximum temperature 850 °C), however, when the maximum temperature was reached the inert gas (N₂) was replaced by the activating gas (CO₂, Argon, and Steam) for fixed periods of time. After this activation time, contact time with the activating agent, the samples were cooled to room temperature in an inert atmosphere.

Table 4: settings used for physical and chemical activation of biochar at the University of Évora

Parameter	Mass Biochar	Heating rate	Tmax (oC)	Duration (min)
CO2 activated biochar	30	10	850	420
Ar activated biochar	30	10	850	420
Steam activated biochar	30	10	850	105
H ₃ PO ₄ activated biochar	30	10	500	60
NaOH activated Biochar	30	10	500	60

In the case of chemical activation processes, chemical agents of different nature, acid (phosphoric acid) and basic (sodium hydroxide) were used. The biochar (~30 g) was impregnated in aqueous solution (60 mL) with the respective chemical agent. The mass ratio “mass of the activating agent/mass of biochar” was 0.5 (in the case of NaOH and also for H₃PO₄). After an impregnation time of 48 h, the impregnated chars were subjected to a pre-drying step at 120 °C for 24 h.

The pre-dried material was placed in the furnace and heated at a rate of 10 °C/min, until reaching a maximum temperature of 500 °C, remaining there for 60 min. The heating and cooling process was carried out in an inert atmosphere (N₂). The obtained materials were washed with distilled water repeatedly until the washing water presents a pH similar to the first one. The final samples were dried in an oven at 120 °C for 24 h.

The ash content measurements were performed according to the standard D2866 - 11 (Standard Test Method for Total Ash Content of Activated Carbon) and the values obtained are heterogeneous.

Capacities for removal of pharmaceuticals

The purpose of the use of activated biochar is to remove pharmaceuticals from wastewater. In order to test their ability to do so, jar tests were carried out by Leaf Wageningen. The biochars samples activated by the university of Évora were used for these tests.

Table 5: Active Biochar tested at Leaf Wageningen

Name	Code	Sample
Biochar 1	C1	carbonized
Biochar 2	C2	physically activated CO ₂
Biochar 3	C3	physically Activated AR
Biochar 4	C4	physically activated steam
Biochar 5	C5	chemically activated H ₃ PO ₄
Biochar 6	C6	chemically activated NaOH
Reference		Chemviron Carbon Pulsorb WP235

The different biochar samples were sieved over a 180 µm sieve to transform them into powder. The powders were then dried. Each sample was added to a bottle with 500 ml of effluent derived from the wastewater treatment plant of Ede, at a concentration of 20mg/l. The steam activated sample was also tested at a concentration of 40 mg/l. The bottles were placed on a shaker for 24 h, at room temperature. The content of the bottles was then filtered and from each bottle a sample was sent to the lab for analysis including a non-treated effluent sample for comparison. In the lab the dissolved organic solids were measured as well as their binding capacity for the 11 reference pharmaceuticals.

3. Results and discussion

3.1. Cellulose screenings

COD and suspended solids were partially removed from the influent by the sieves. The removal percentages show remarkable differences (between 7 to 48% for COD and 8-80% for suspended solids) which can probably be explained by dilution effects of rain (data not shown).

Figure 13 shows the percentages of solids and ash in the samples of sieved material taken at different sampling days.

The sieved material was analyzed for the content of solids and ash. The percentages of solids are rather stable. The ash content is variable but already high in the sieved material which is unfavourable as the ash content will become even higher during the rest of the processing steps.

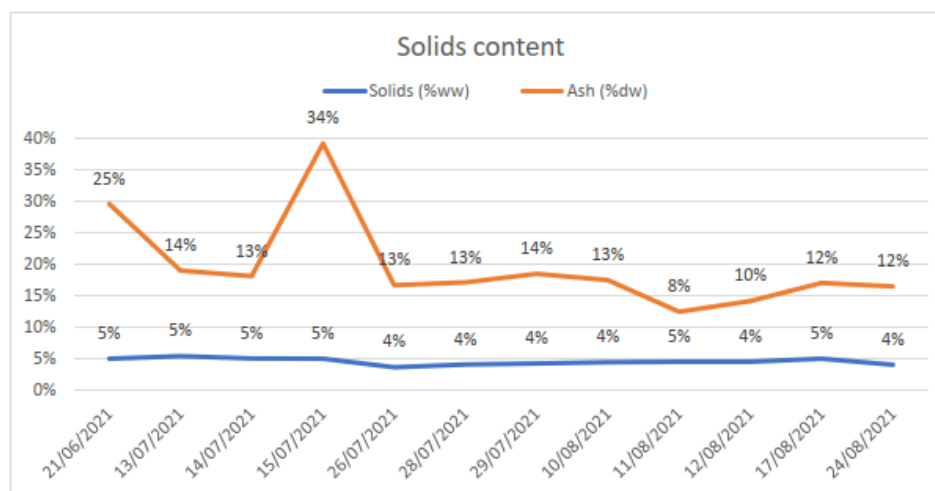

Figure 13: Dry matter content and Ashcontent in the sieved material

The increase of ash content during the process is illustrated in the figure below where hourly samples of the sieved material were compared to samples of the same material after pressing.

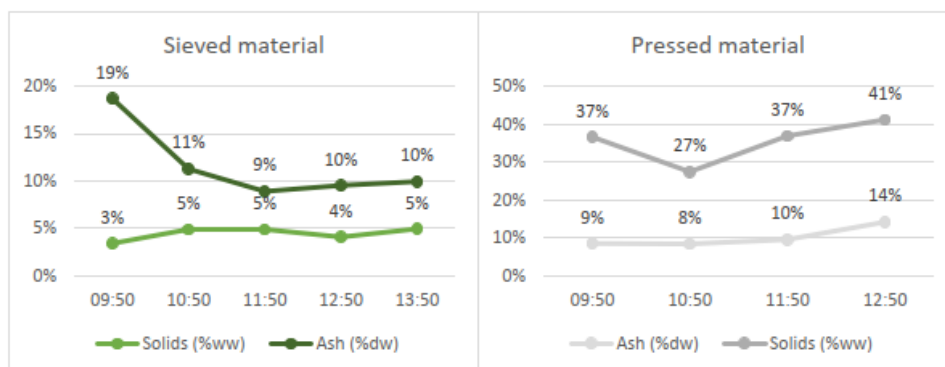

Figure 14: Solids and Ash of the sieved material vs pressed material

Sand is the most important constituent of the ash (50%) in the sieved material, the other 50% consists of various heavy metals, mainly aluminium.

Table 6: Average quality sieved material

Parameters	Average	Unit
Dry matter content	4,2	%
Ash content	12,6	%DS
Aluminium	2300	ug/l
Arsenic	2,5	ug/l
Cadmium	0,21	ug/l
Chrome	10,8	ug/l
Copper	69,33	ug/l
Mercury	0	ug/l
Lead	41,7	ug/l
Nikkel	6,0	ug/l

3.3. Pyrolysis

This Pyrolysis set-up was operated for 6 days with different run-times. These runs were at some point interrupted due to different instabilities in the system. In most cases the temperature became too high and the reactor then was turned off for safe operation. High temperatures are advantageous for the production of bio-oil and syngas but lower the yield of biochar.

The table below shows the run times as well as the amount of biochar produced.

Table 7: the production batches of biochar that have been done

Date	Time	Mass pellets	Cumulative Pellet Consumption	Average temperature	Max temperature
Mm/dd/yyyy	(mm:ss)	(kg)	(kg)	(oC)	(oC)
06/21/2021	X	50,9	50,9	X	X
06/30/2021	X	10,9	61,8	X	X
07/06/2021	9:50	9,6	71,4	564	750
07/07/2021	13:50	12,2	83,6	512	789
07/13/2021	28:40	26,1	109,7	604	999
07/21/2021	76:20	77,8	187,5	568	750

X: not recorded/no data available

The average pellet consumption rate for the last 4 production days was about 60 kg per hour which is in accordance with the design parameters. Figure 6 shows the temperature during a run of 1,5 hours.

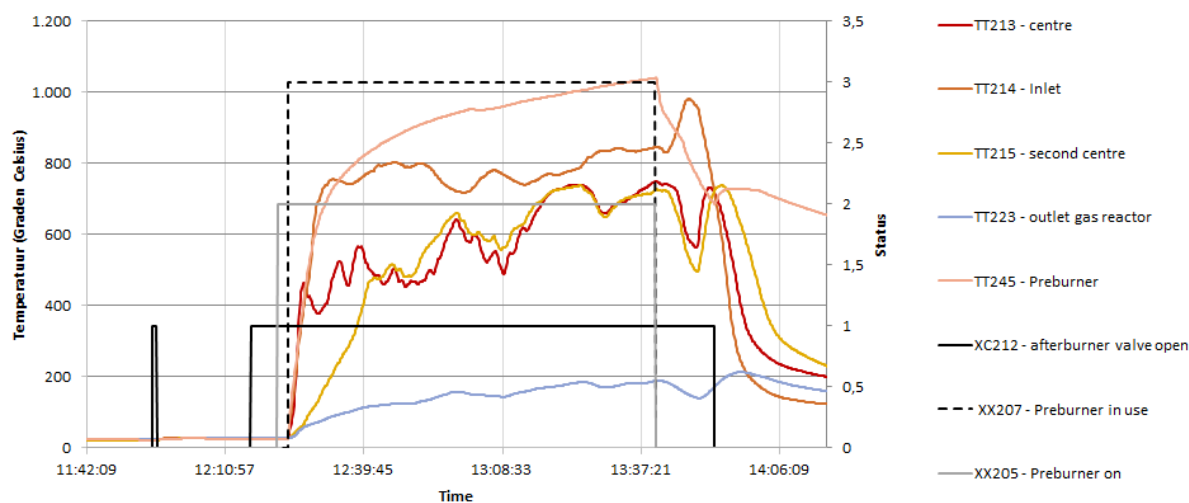

Figure 15: The temperature inside the reactor and in the preburner

5 minutes after the initial opening, the preburner is turned on. The valve to the reactor is opened after 3 minutes after which the temperature starts increasing inside the reactor. The inlet temperature quickly rises to 850 degrees Celsius. The gas leaves the reactor at 180 degrees. All temperatures keep rising during the 1,5 hour. Then the system was shut down because of reaching too high temperatures.

The temperature rises due to a build-up of heat which is caused by the reactor not needing as much energy as delivered by the Syngas when it is burned in the afterburner. Due to this, the temperature in the

whole system rises. The system tries to control the temperature by reducing the amount of propane, but even with the propane totally reduced, the temperature kept on rising, after which the system shuts down.

Biochar

The biochar produced on 21 July 2021 consists of powdered biochar as well as still intact pyrolyzed pellets. The colour is greyish which indicates that the organic content is low.



Figure 16: Biochar produced

Table 8 shows the quality of the Biochar produced compared to the biochar produced from sieved material from Aarle Rixtel (laboratory tests).

Table 8: Properties produced biochar compared to biochar from the WWTP of Aarle-Rixtel

Property	Unit	Sieved material pellets	Biochar Pellets Ede	Biochar pellets Aarle-Rixtel
Γ_{Bulk}	kg/m ³	443	263	
Γ_{pellet}	kg/m ³	930	490	
Dry solids	%	95.3	95.3	
Ash content	%DS	11.1	39.0	

The ash content in the biochar is almost 40 %. The high ash content (which is not possible to activate) and therefore low organic carbon content, has a big (negative) impact on the active material and its surface area. More extensive optimization should be conducted to the pyrolysis process to improve the quality of the biochar. However, the inorganic content of the dried and pelletized already was relatively high (11 %). As the reactor temperature could not be kept low enough a lot of the organics are directed to the syngas as well as to the bio-oil and the pyroligneous acid.

Low cellulose content sievings

The sievings contain large amounts of toilet paper which mainly consists of cellulose. The concentration of

lignines and hemicellulose is low compared to other agricultural sources for production of biochar and biocoal. During pyrolyzation cellulose easily degrades to for instance the gas phase resulting in low biochar yields. Also during activation another large organic fraction disappears and results in a low yield of activated carbon.

Bio-oil

The bio-oil produced separated itself into two layers, a dry/compact/solid layer and a wet/fluid layer. The results from the analysis on the quality of the produced bio-oil, are shown in table 9 compared to other (bio)-fuels.

Table 9: Composition of bio-oil compared with other bio-oils and burner fuels

Parameter	Pyrolysis oil Ede (dry)	Pyrolysis oil Ede (wet layer)	Pyrolysis oil Aarle-Rixtel (dry)	Pyrolysis oil Aarle-Rixtel (wet layer)	Heavy Fuel oil	Fast Pyrolysis Oil (MDPI)
Water wt%	12	73	18	50	0	25,5
Density kg/l	1,017*	1,060			0,99	1,256
Ashcontent %	0,8	57	0,3	0,2	0,08	-
LHV (MJ/kg)	28	<1	26,1	20,6	40,6	16,9
HHV (MJ/kg)	30	<1	28,1	22,1		

The Bio-oil has a higher ash content than other bio-oils. The (thick solid) dry fraction ash content was in a range comparable to other bio-oils and also the lower and higher heating value (LHV and HHV) can be considered as good and were even higher than some other bio-oils.

The solid dry fraction contains the most calorific value, partly due to the relatively low water fraction. The ash residue in the solid dry fraction is higher than in other pyrolysis oil from literature. A higher ash content might be problematic when it is used as biofuel.

Furthermore, the watercontent of the 'wet layer' was high. The wet layer has no calorific value.

The influence of temperature on the density of the different fractions is shown in figure 15, where the density of the solid fraction at room temperature was not measured because the oil was too sticky for an accurate measurement:

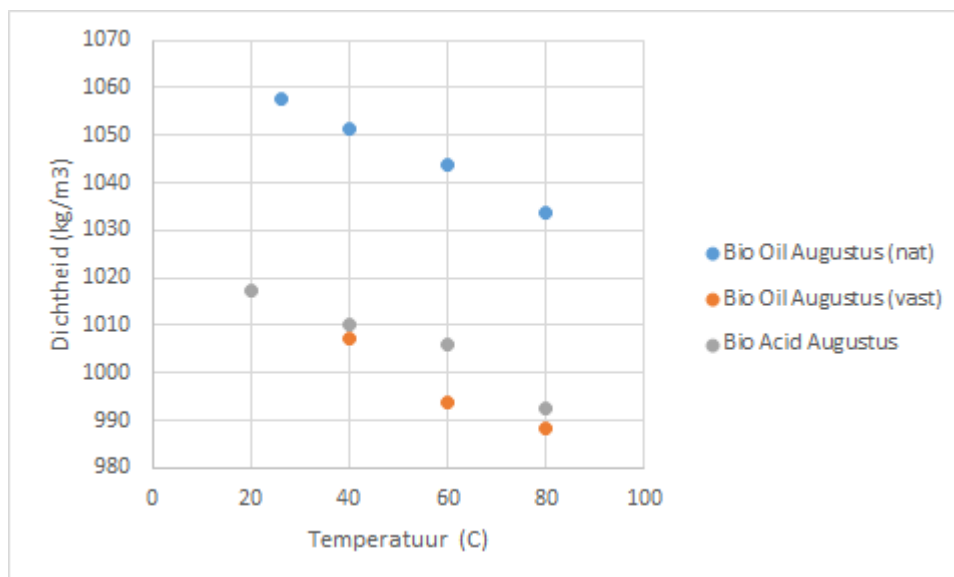

Figure 17: Density vs temperature of Bio-oil (dry and wet layers) and pyroligneous acid

Pyroligneous acid

The pyroligneous acid results compared to the results from Aarle Rixtel (earlier laboratory experiments with pyrolization of cellulose sievings) are shown in table 10 below. The ash content in the pyroligneous acid in the Ede acid is considered to be high which means it is polluted with salts. The acid also contains sediments/solids which indicates that the separation of the bio-oil, char and acid is not very well.

When the top layer (without sediments) is analysed however the ash content is lower and the 0,2 % ash content compares better with the results from the Aarle Rixtel acid.

Table 10: Analysis on the pyroligneous acid produced

Parameter	Pyroligneous acid Ede (total)	Pyroligneous acid Aarle Rixtel
Water wt%	87	41
Density kg/l	1,017	
Ashcontent % of DS	20	<0,1
LHV (MJ/Kg)	<1	<1

To assess what the composition of the acid is several components were measured. Indicators for toxic components, like PCB's, AOX and other micropollutants, were under the detection limit. Heavy metals were all below the detection limit except for Zinc (614 mg/kg).

The overall carbon content was 5,6 % C (weighted) and the overall hydrogen content was 8,6 %. The overall hydrocarbons concentration is 50-100 kg/m³. To be able to judge what the pyrolytic acid will contribute to the biological phosphorus removal and denitrification in the STP the concentration of volatile fatty acids is most interesting. The main VFA's measured were acetic acid with 6,3 kg/m³ and propionic acid with 0,9 kg/m³. The COD of the total VFA's is about 8 kg/m³. Suppose the acid production for all sievings for the pilot (50.000 PE) is 20 kg/h the load on VFA's can be calculated to $20 \cdot 24 / 1000 \cdot 8 \text{ kg/m}^3 = 3,8 \text{ kg COD/day}$. A 50.000 PE STP would have an influent loading (after primary sedimentation) of about 3.000 kg COD/day and 1.200 kg BOD/day. It therefore can be concluded that the amount of VFA's are very small compared to the COD/BOD loading of normal influent and that no substantial impact on the biological denitrification or phosphorus removal is to be expected.

3.4. Activation

In the following paragraphs, the results of the activation methods will be discussed.

University in Belgium (Hasselt)

Prior to each analysis, all samples were uniformly grinded in a ball mill.

Based on the TGA (thermogravimetric analysis), the biochar contains more than 30% ash. After activation, given a yield of 44%, the ash content becomes higher than 70%. After activation of a duplicate sample, a screen filtration was applied, to make a rough separation between coal and ash. This was only partially successful, with the coarse fraction (>1mm) having an ash content of 66% and an increasing fixed C content of 32%. The TGA analyzes on the ACs indicate that it's volatile material is effectively close to 0, indicative of an AC material.

BET (Brunauer-Emmet-Teller) analysis on the biochar indicate that the specific surface area of the input material is very low. Activating this material results in a low specific surface area of around the 200 m²/g. The high ash content is a limiting factor for the development of a good specific surface. Determinations of iodine levels were not performed because, given the low specific surface area of the char, too much sample had to be used for analysis to get reliable data.

It can be concluded that the biochar samples supplied to the University could not be activated properly mainly because of the already high ash content in the biochar. This biochar was produced during days with high flows to the WWTP because of rains. The rainwater probably carried relatively large amounts of sand to the plant which ended up in the sievings up to the biochar as well as in the other products.

University in Portugal

Activation was carried out while trying to avoid destroying the material (as happened in the former activation tests). The Ash content was measured after the different activation methods.

Table 11: Results ash content after before and after activation

Sample	Ash content / %
C1 (carbonized)	51,2
C2 (physically activated CO ₂)	86,8
C3 (physically Activated AR)	83,9
C4 (physically activated steam)	78,7
C5 (chemically activated H ₃ PO ₄)	29,3
C6 (chemically activated NaOH)	40,4
Precursor (biochar)	35,7

The ash content after the physical activation methods is on average twice as high as the chemical activation methods. With physical activation, a large part of the organics is lost. In particular the samples prepared by physical activation (with CO₂, Ar or Steam) had high ash contents (values above 78%).

Regarding the samples prepared by chemical activation the values are more reasonable and similar to the biochar. In this case no further reduction of the organics took place during activation.

In the next paragraph the activity of all these chars were tested for the removal of pharmaceuticals.

3.5. Removal efficiency for pharmaceuticals

The capacity of the activated biochars for the removal of pharmaceuticals were conducted in jar tests with effluent from the WWTP Ede. A (fossil) commercially available powder activated carbon (Chemviron Carbon Pulsorb WP 235) was used as a reference. A dose of 20 mg/l of biochars was applied to the effluent samples to ensure that some removal could be measured (because of the low organic contents). Normally the dosing in PACAS systems (powder activated carbon in activated sludge systems) is 10-15 mg/l. With the steam activated sample (biochar 4) also a concentration of 40 mg/l was applied.

In Table 12, the concentrations of the different pharmaceuticals are shown from the untreated sample (blanco, this is the effluent from the WWTP) and the end result of the activated samples. "Referentie" is the reference powder activated carbon (Pulsorb) sample.

Table 12: the concentrations of the guiding substances before and after the adsorption tests with the different activated biochars

	t=0	t=eind								
	effluent rwzi Ede	Blanco	referentie	Biochar 1	Biochar 2	Biochar 3	Biochar 4	Biochar 5	Biochar 6	Biochar 4
Poederkool (mg/l)		0	20	20	20	20	20	20	20	40
<i>Gidsstoffen</i>										
1,2,3-benzotriazool	2,5±0,0	2,4	0,17	0,69	2,2	1,4	2	1,1	0,95	1,5
som 4- en 5-methyl-1H-benzotriazool	1,9±0,1	1,9	0,06	0,46	1,6	0,83	1,2	0,66	0,61	0,66
carbamazepine	0,39±0,01	0,38	0,01	0,26	0,35	0,3	0,28	0,3	0,32	0,17
diclofenac	0,47±0,00	0,49	0,11	0,37	0,44	0,38	0,36	0,41	0,43	0,26
gabapentine	1,3±0,1	1,3	1,2	1,3	1,3	1,3	1,3	1,3	1,3	1,4
hydrochlorothiazide	1,4±0,0	1,4	<0,5	0,9	1,4	1,2	1,1	1	1,2	0,8
irbesartan	1,2±0,1	1,1	0,45	0,94	0,99	0,93	0,83	1	1	0,52
metoprolol	1,4±0,0	1,4	0,01	0,6	1,1	0,72	0,64	0,48	0,51	0,18
sotalol	1,4±0,1	1,3	0,07	0,92	1,2	1,1	1,1	0,84	0,99	0,79
trimethoprim	0,13±0,01	0,13	<0,05	0,07	0,1	0,08	0,07	0,05	0,08	<0,05
venlafaxine	0,25±0,00	0,24	0,01	0,21	0,24	0,21	0,21	0,22	0,21	0,16
<i>Overige stoffen</i>										
amisulpride	0,09±0,00	0,08	<0,01	0,04	0,07	0,05	0,04	0,03	0,04	0,01
azitromycine	0,6±0,1	0,6	<0,1	0,4	0,5	0,3	0,3	0,4	0,4	<0,1
candesartan	0,20±0,01	0,18	0,16	0,19	0,19	0,18	0,19	0,18	0,18	0,17
citalopram	0,21±0,01	0,2	<0,01	0,08	0,16	0,08	0,06	0,09	0,08	0,01
claritromycine	0,09±0,01	0,08	<0,01	0,07	0,09	0,05	0,03	0,08	0,08	<0,01
furosemide	1,1±0,0	1	0,2	0,9	1,1	0,9	0,8	0,9	0,9	0,6
propranolol	0,09±0,01	0,08	<0,01	0,01	0,04	0,01	0,01	0,01	0,01	<0,01
sulfamethoxazol	0,44±0,02	0,42	0,26	0,42	0,4	0,38	0,38	0,41	0,42	0,37

In figure 18 the average removal capacity is shown of the 11 pharmaceuticals (guiding substances in the Netherlands). The Pulsorb activated carbon has an average removal efficiency of 77 % which is to be expected from a commercially available PAC.

Interestingly also the not activated biochar (Biochar 1) shows already a quite good removal of 36 %. Normally (not activated) biochars show poor or zero removal of pharmaceuticals. The average removal efficiency of 36 % might have been caused by the (too) high temperatures in the pyrolysis reactor which might have resulted in some kind of thermal activation.

The physical activated carbons (C2, C3 and C4) only remove 10-26 % which probably is caused by the loss of organics during the activation.

The chemically activated biochars (5 and 6) have slightly lower, but similar, removal efficiencies compared to the not activated biochar 1. Apparently also these activations were not successful although the organic content stayed the same during the activation.

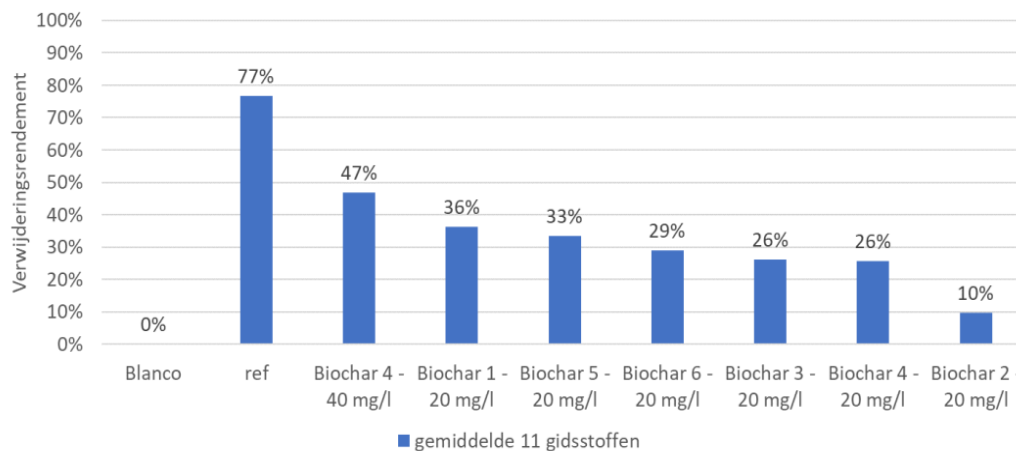

Figure 18: average removal efficiency for all 11 guiding substances

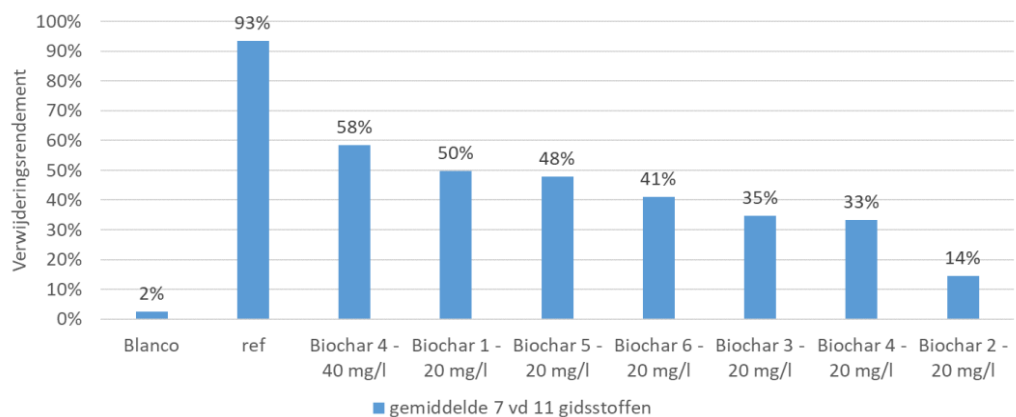

Figure 19: average removal efficiency for the 7 guiding substances with the highest removal efficiencies

In the Netherlands the regulations for removal of pharmaceuticals are set to 70 % for 7 out of the 11 pharmaceuticals (guide substances). One may choose the average removal capacity of the 7 pharmaceuticals with the highest capacity. These results show that the removal capacities for the 20 mg/l dosed activated biochar are between 36-10%, when looking at all tested activated substances.

The carbonized biochar sample (Biochar 1) is performing the best and the physically activated biochar with CO₂ (Biochar 2) is performing the worst. Furthermore, these results suggest that the higher the ash

content of the biochar, the lower the removal capacity which is as expected. A similar trend can be seen when only taking into account the 7 best removal rates.

The increase in ash content (loss of organics) seems to outweigh the activation process resulting in lower adsorption capacities.

The 40 mg/l dosage is performing significantly better than the 20 mg/l dosage suggesting that the limiting factor is the adsorption capacity of the biochar.

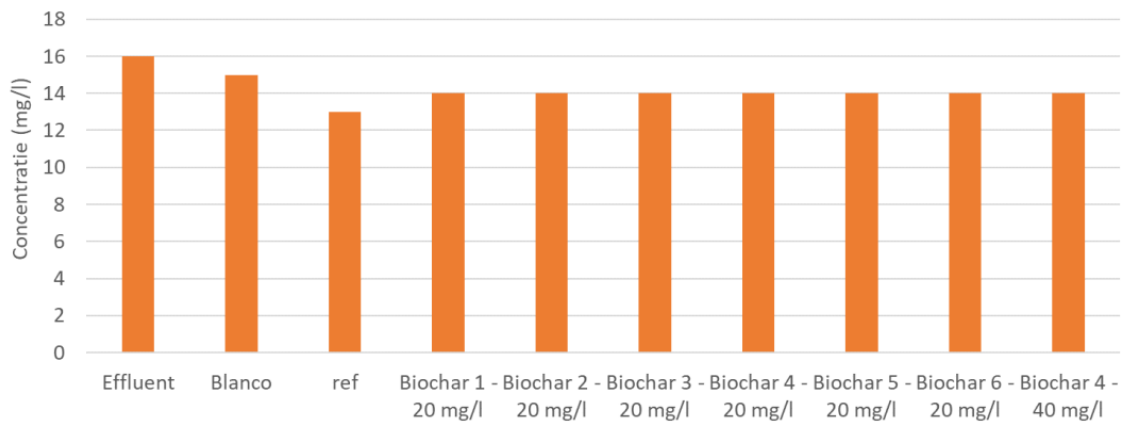

Figure 20: DOC concentration per biochar test

The DOC (dissolved organic carbon) removal values are similar for all biochars thus indicating that the activations were not successful.

This table shows the average removal capacities of the individual samples for the different pharmaceuticals.

Table 13: removal efficiencies per guiding substance per biochar tested

	Blanco	referentie	Biochar 1	Biochar 2	Biochar 3	Biochar 4	Biochar 5	Biochar 6	Biochar 4
poederkooldosering (mg/l)	0	20	20	20	20	20	20	20	40
1,2,3-benzotriazool	4%	93%	72%	12%	44%	20%	56%	62%	40%
som 4- en 5-methyl-1H-benzotriazool	-3%	97%	75%	14%	55%	35%	64%	67%	64%
carbamazepine	1%	97%	32%	9%	22%	27%	22%	17%	56%
diclofenac	-5%	76%	20%	5%	18%	23%	12%	8%	44%
gabapentine	-4%	4%	-4%	-4%	-4%	-4%	-4%	-4%	-12%
hydrochloorthiazide	0%	<u>64%</u>	36%	0%	14%	21%	29%	14%	43%
irbesartan	4%	61%	18%	14%	19%	28%	13%	13%	55%
metoprolol	0%	99%	57%	21%	49%	54%	66%	64%	87%
sotalol	4%	95%	32%	11%	19%	19%	38%	27%	41%
trimethoprim	-4%	<u>60%</u>	44%	20%	36%	44%	60%	36%	<u>60%</u>
venlafaxine	4%	96%	16%	4%	16%	16%	12%	16%	36%
Gemiddelde verwijdering 11 gidsstoffen	0%	77%	36%	10%	26%	26%	33%	29%	47%
Gemiddelde verwijdering 7 gidsstoffen met het hoogste rendement	2%	93%	50%	14%	35%	33%	48%	41%	58%

3.6. Design full scale plant

During the preparation for this project preliminary calculations indicated that amount of activated carbon produced from the cellulose sievings might be sufficient to get a good, enhanced removal of pharmaceuticals in a conventional WWTP. Above that the syngas produced was supposed to be sufficient for the heating of the dryers and the pyrolyzation reactor. And the bio-oil and pyroligneous acid were extra products which could be used in the WWTP itself or by other parties.

The production of sievings and the dewatering, as well as the drying performed as expected. Those parts of the plant, especially the influent sieves and the dewatering to 50 % is proven technology.

However, we have experienced some less favourable results at the following stages:

1. The flash pyrolyzation reactor was difficult to control. The temperature often became too high and too many organics were lost in the process thus lowering the yield of biochar by a factor 2.

2. The amount of syngas produced seems to be enough to run the dryers as well as the pyrolyzation reactor which is positive. But it probably is caused by too much degradation of organics during pyrolyzation.
3. The extra products bio-oil and pyrolygneous acid can not be separated well from each other and from the biochar. The products all seem to be 'polluted' with salts and metals (high ash contents) making them less suitable for use by other companies.
4. The pyrolyzation could only be operated in batch mode while continuous operation would be needed to optimize the use of syngas, to control the temperature in the reactor and to be able to produce and separate a stable set of products.
5. The different types of chemical or physical activations did not result in well activated carbons. The removal efficiencies for pharmaceuticals did not improve.
6. Activation on site is a complex and dangerous process because of high temperatures and pressures or concentrated chemicals. This is not possible on a WWTP site.

To apply this set of processes the following set up is recommended:

1. At all WWTP's cellulose sievings could be produced by installing finesieves. Preferably after the sand/grit chambers which take out the sand first. The finesieves as well as the dewatering to 40-50 % can easily be automated and performed by the WWTP personnel.
2. The pyrolyzation however requires a large scale (perhaps over 1 million PE) and should be carried out in a continuous process (day and night), which is not possible at a WWTP.
3. Therefore, a centralized pyrolyzation installation should be built to serve a whole region and all WWTP's in that region should truck their dewatered sievings to that location.
4. The selection of the right type pyrolyzation reactor is still complicated to advise on. One should focus on one product not all for as was done in the pilot (biochar, bio-oil, syngas and pyrolygneous acid). The focus should be on either biochar or on bio-oil.
5. To be able to get well activated carbon the biochar produced probably should be mixed with other biomasses (with larger content of lignines etc.) to get a better product for the removal of pharmaceuticals.

4. Conclusions

The finesieves proved to be a mature and proven technology, which can be operated continuously. This applies for the finesieves as well as for the dewatering unit which dewateres the sieved material to 40-50 % dry solids.

Also, the drying and pelletization units were performing relatively well. The pyrolysis process however was too complex (lot of equipment and sensors) and the flash pyrolysis reactor could not be operated continuously and it proved to be very complicated to obtain stability. The installation required continuous attention and close surveillance. The risks of high temperatures and the production of syngas were abated by following ATEX procedures and forced to operate the installation only during working day hours.

The reactors/components were started up step-by-step and the buffers were filled with the intermediate products. From each buffer the next stage was fed. This way, all processes could be uncoupled and optimized while the focus was set on that specific stage. So, all operations were in fact batch operations.

In the set-up of the WWTP in Ede, the influent is not being treated by a sand/grit removal which resulted in relatively high percentages of sand in the sieved material thereby increasing the anorganic content of the sieved material as well as in the final products (especially the biochar and activated carbon).

The drying and pelletization section consists of a chain of units including a burner, a pre-dryer, a pelletization unit and a secondary drying unit. The intention was to use the syngas derived from pyrolysis for the drying processes but due to complications with this process, the drying took place mostly with propane. However, it can be stated that the amount of syngas produced will cover the gas consumption needed for the drying process.

The quality of the pellets (90 % dry solids) was strong and very well suited to be fed to the pyrolysis reactor.

The pyrolysis process turned out to be complicated and difficult to control. The batchwise operation resulted in a wide temperature range in time in the reactor. Several runs were done with different temperatures resulting in varying product quantities and qualities. To separate the products after the pyrolyzation was also not easy. The biochar was well separated from the bio-oil and the pyroligneous acid but the latter two were not clearly divided. It would have required a lot more time for commissioning and this was not possible unfortunately, due to the bankruptcy of PH.

The inorganic content (ashes) of the biochar, 35-40%, is very high which can be explained by the high percentages of sand in the sieved material as well as the high temperature at which the pellets were carbonized. The low organic content lowers the potential of the use of biochar in agriculture as well as the potential for activation. For proper removal of pharmaceuticals from the wastewater, highly activated carbon is mandatory.

Laboratory activation tests were performed on the activation of the biochar at Universities in Belgium and Portugal. Physical/thermal activation (steam, CO₂, argon) resulted in quite an extra loss of organics. The chemical activation with acid H₃PO₄ or base NaOH did not show this loss of organics. Activation with H₃PO₄ even lowered the ash content somewhat. However, in all activation tests the removal efficiencies did not improve significantly compared to the biochar that was not activated. The removal of pharmaceuticals remained around 35 %. In the next phase of the WOW! Project, in the capitalization call, where the biochar will be used for removal of pharmaceuticals in wetlands, will be chosen for *biological* activation. Biological activation is a different process which enriches the biochar with bacteria and fungi.

The pilot plant had a theoretical capacity to treat the amount of influent of 50.000 PE. It therefore could be considered as a *demonstration* plant. But because of the complexity of especially the pyrolysis and the activation, and the need for continuous operation and surveillance (24/7) it is not suitable to carry out these processes at the premises of a WWTP. A regional pyrolysis and activation plant serving a population of several millions of people (several WWTP's) might be a more promising solution. The pyrolysis and the activation should be designed to be flexible in retention time, temperature and activation methods to be able to produce the right quality and quantity of products. If the focus is on biochar the temperature should be controlled well to avoid that large amounts of organics are lost. Physical and chemical activation did not seem to be successful and the focus perhaps should be on biological activation. If the focus is on bio-oils high temperatures are needed.

5. References

Hassan, M., Liu, Y., Naidu, R., Sanjai, J.P., Du, J., Qi, F. & Willett, I.R. (2020). Influences of feedstock sources and pyrolysis temperature on the properties of biochar and functionality as adsorbents: a meta-analysis. *Sci. Total. Environ.*, 744: 140714

Several STOWA reports on the recovery of cellulose and the removal of pharmaceuticals (www.stowa.nl/publicaties)

Project partners



WOW! is supported by the Interreg North-West Europe program.

WWW.NWEUROPE.EU/WOW

